



**CANK
ELECTRICAL AND ELECTRONIC
ENGINEERS**

Creating a world of new possibilities



COMPANY PROFILE

-  Suite 7 Monavale Shopping Complex
177 Lyndhurst Road, Monavale, Harare, Zimbabwe
-  +2638644150180
-  +263 772 615 511 / +263 718678115 / +263 733881835
-  info@cankengineers.co.zw
-  www.cankengineers.co.zw





WHO ARE WE?

CANK Electrical Engineers Pvt Ltd t/a Cank Electrical and Electronic Engineers has been providing electronic engineering services to the Zimbabwean community since 2014. We are made up of young vibrant engineers dedicated to provide quality services in competitive, positive, close controlled and professional manner. As CANK, we are so proficient in the execution of projects. Our field of expertise covers all types of electrical and electronic building services in projects as diverse as showrooms, banks, commercial and retail complexes, service stations, housing, sporting facilities and many more. Our contract management knowledge ensures that projects are undertaken according to plan, within budget and with a cooperative attitude.

We intend to make working with CANK an easy process and we know this can only be done with good communication skills and understanding of the correct use of contract management tools: reporting, evaluation and a flexible imaginative approach to solving problems.

In 2020 CANK Electrical & Electronic Engineers was restructured to form four subsidiaries namely Smart World Technologies, Solar Links Zimbabwe, Black Stallion Security Services and Electroquip Manufacturers and Suppliers. Ensuring each subsidiary concentrates in a particular field and we are glad with years of experience our complementary styles of experience has made us to be the best in the country.

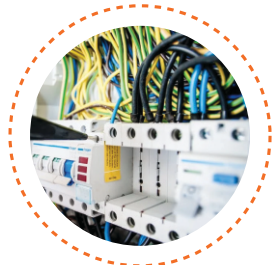



ORGANOGRAM

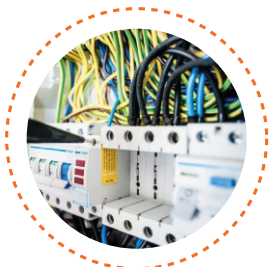
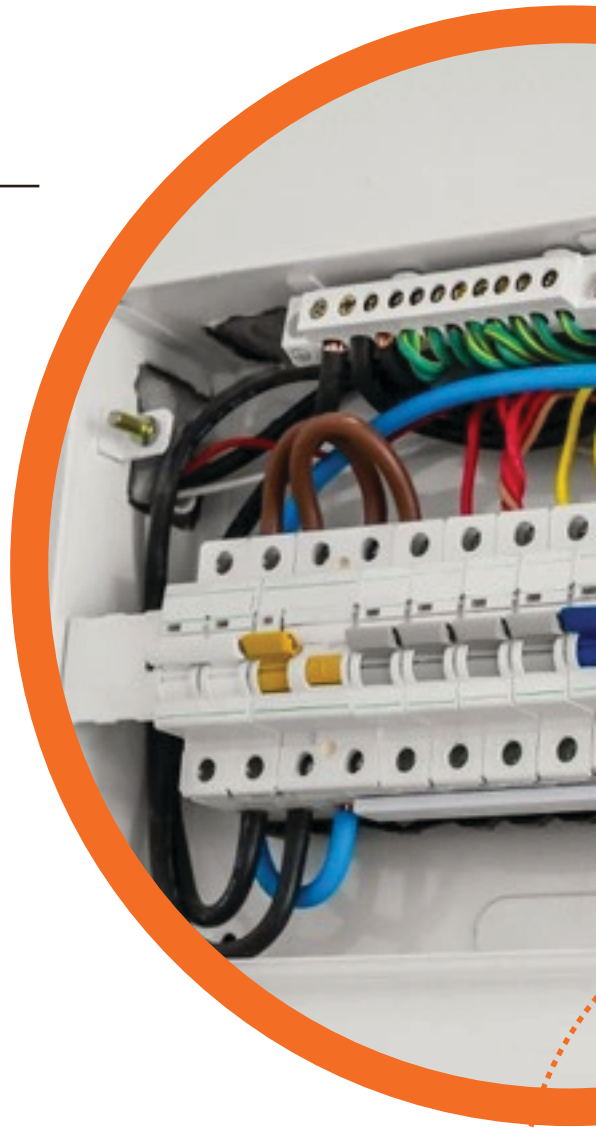
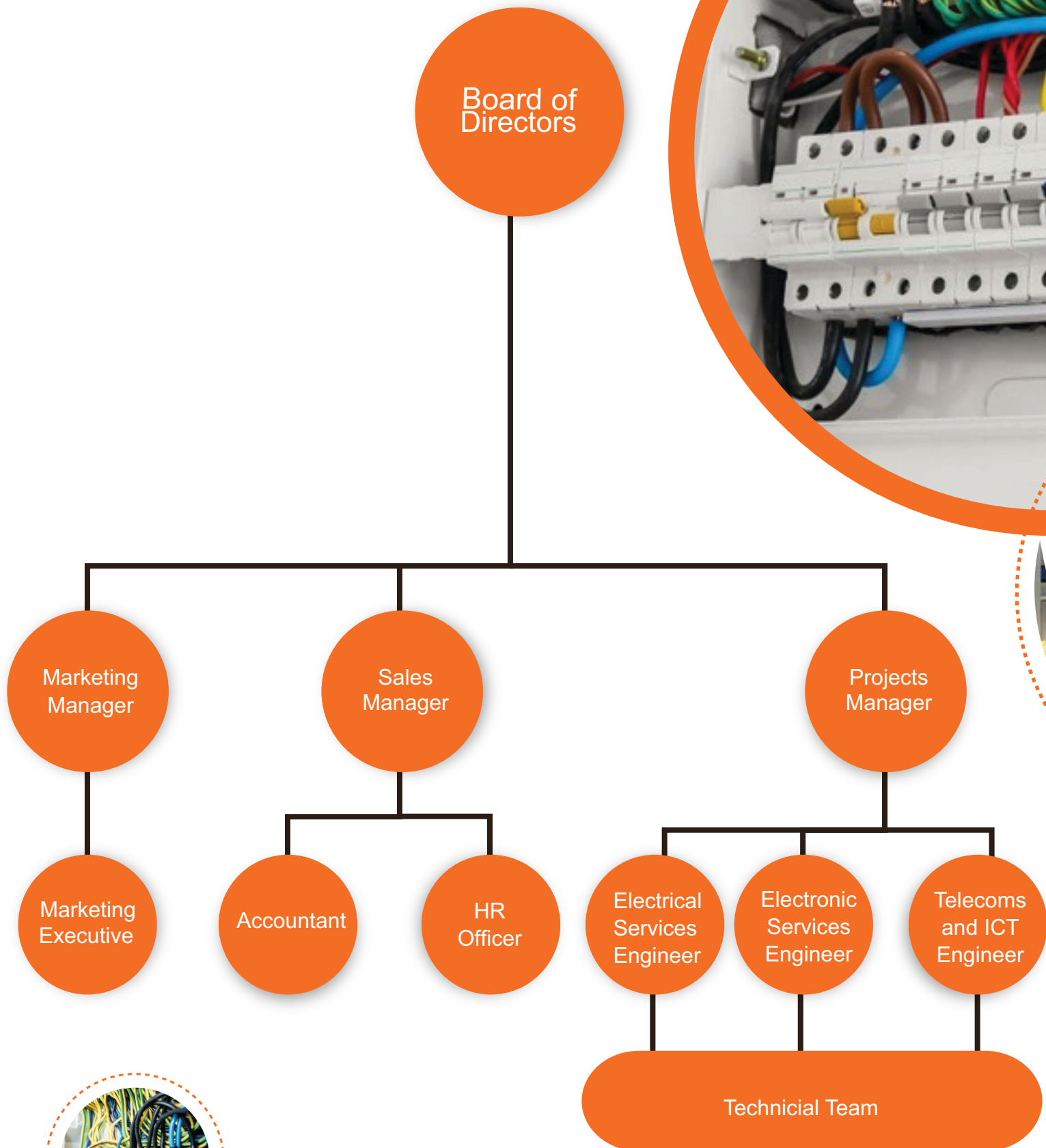

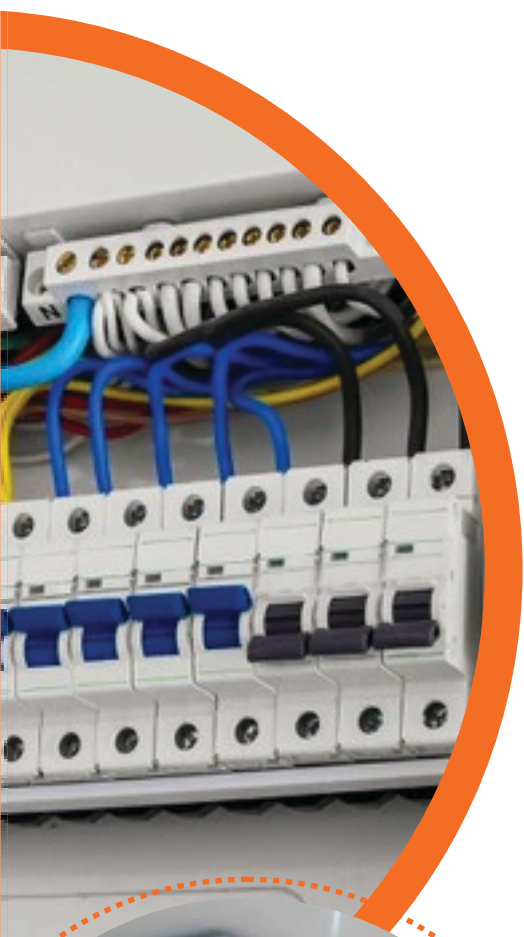

Our Business



Our Business

Our core business at CANK is providing high quality ICT, Electrical and Electronic engineering contracting services. The firm has a versatile team of professionals with many years of experience in this field of business.



Our Mission

To provide high quality and reliable products and services at reasonable costs to our clients, through innovative research and systems implementation.



Our Vision

To be the most preferred cost impressive provider of ICT, Electronic and Electrical Systems in Zimbabwe and beyond.



Our Values

Honesty
Excellence in customer service integrity
Innovative
Hard working





Our Services



**CANK
ELECTRICAL AND ELECTRONIC
ENGINEERS**

Creating a world of new possibilities

www.cankengineers.co.zw

Power factor correction and improvement
Energy audits
LV, MV and HV distribution and sub-transmission
Substation construction and maintenance
Underground and overhead reticulation
Lighting protection systems
Cable jointing PILC and XLPE
Planned and reliability centered maintenance
Ducting and trunking



www.smartworld.co.zw

Smart Home Automation and Control Systems
Smart lighting, smart audio, smart video, smart curtains and blinds,
smart security
Design and Implementation of remote monitoring systems
based on Internet of Things (IoT) and Cloud computing and
other Controller based projects



www.blackstallion.co.zw

CCTV and security cameras
Access control (keypad, tag and biometrics)
Security fencing
Intruder, Fire and Car Alarm
Video Conferencing
Paging and PA system
PABX and VOIP
Gate automation and intercoms (video/audio)
Vehicle tracking and control



www.solarlinks.co.zw

Design, supply, installation and maintenance of all
solar systems



www.electroquip.co.zw

Manufacturing and supplying of all electrical
accessories and equipment i.e Distribution Boards
Meter Boards, Cansisters, Manhole Covers, Pedestals
Ceiling and Skirting Trunking, Motor Control Panel
and Starters e.t.c.





Our References

Cank Electrical and Electronic Engineers has and is executing small, medium to large scale venture infrastructure. Led by a team of qualified and dedicated personnel. The following clients among others have commissioned our firm as contractors on their projects.

Project	Period	Reference
Garden Flats St Luis Road Marlborough, Harare	Installation of Electrical power and lighting August 2013 to June 2014	Mr M Murera Murera Construction 0776 829 125
Minibay Investments	CCTV installation November 2013	A Chareka (Client) 0772604508
Econet Shop Mutare	Installation of Electrical Power Systems August 2014 -November 2014	Mr W Nengo Nengo Contractors 0772515353
Norton and Esigodini Magistrate Courts	Installation of electrical Power and Lighting Feb 2014-August 2014	Mr W Nengo Nengo Contractors 0772515353
Home Economics Block Kuwadzana 2 High School	Installation of Electrical power and lighting Feb 2014-August 2014	Mr R Mushoperi Robmeck Construction 0772385769
Monovale Shopping Complex	Installation of Electrical power and lighting August 2014-November 2014	Dr C Duri (Client) 0772248274





Our Gallery



Project

Period

Reference

Renovations Schweppes
Willowvale, Harare

Installation of Electrical power
and lighting
June 2015

Mr W Nengo
Nengo Contractors
+263772515353

Tongaat Hullet, Triangle

Installation of fire detection
system
September 2015 to December
2015

Mr M Mlilo
Equal Image
+263737221121

Send Money Home

Wi-Fi Installation and
configuration of access points
December 2016

Mukundi Murefu
(Client)
+263774959186

Westview High School

Installation of electrical power
and lighting
Feb 2014-April 2017

Mrs M Rusere
(Clerk)
+263775377249

Renovations ,UNESCO Offices,
Newlands, Harare

Installation of electrical power
and lighting, access control and
metal detectors
September 2017

W Mainja
Kassavi Construction
+263773284055

Election Resources Centre

Installation and commissioning
of a call centre
Nov 2021 - till present

Ignatius
(IT Manager)
0772 573 823

Madokero Storage Sheds

Electrical and electronic services
drawings
Project management and consultancy
Nov 2020

Shingi Ndoro
(Exodus and Sons)
+263772573823

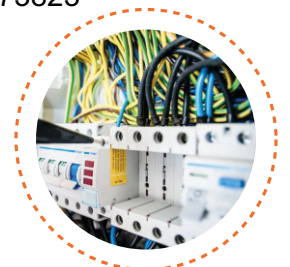



Our Gallery



Electrical and Electronic Services Drawings
 Electrical and Electronic Services Installations
 3D Lighting Drawings
 Smart Home Automation
 15kva Solar System

CHIPEMBERE HOUSE (GLETWIN) 2020



Supply and installation of 5KVA solar system
 12 x 330 Solarcom Solar Panels
 2 X Us3000 Pylontech Li Ion Battery
 1 x Phocos 5KVA Anygrid Inverter

MANJEWE SAFARI LODGE (BIKITA) JUNE 2020



Electrical and Electronic Services Drawings
 Electrical and Electronic Services Installations
 3D Lighting Drawings
 5kva Solar System

ISHEUNYORO (BELVEDERE) 2020-21

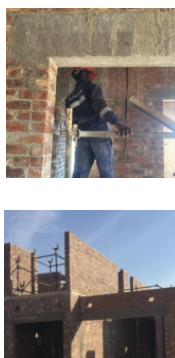

Electrical and Electronic Services Drawings
 Electrical and Electronic Services Installations
 3D Lighting Drawings
 Smart Home Automation
 15kva Solar System

HOUSE BADZA (HAYDON) 2020-21





Our Gallery

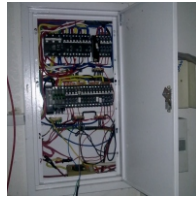

Electrical Services Installations



ECONET SHOP (MUTARE) 2014



Electrical Services Installations

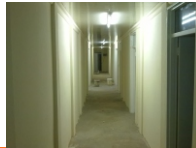

MAGISTRATE COURT (NORTON) 2014



Electrical and Electronic Services Installations
Fire alarm system
5kva Solar System



HOUSE MAVHUNGA (SHAWASHA HILLS) 2019



Electrical and Electronic Services Installations



CRESTA LODGE RENOVATIONS (HARARE) 2019





Our Key Personnel



Managing Director
Collins Tafadzwa Mano



Qualifications

- o City and Guilds Advanced Diploma in Applied Electrical and Electronics Engineering
- o Class 1 Electrician
- o Certified Sperosens Fire Alarm Technician
- o B Tech Electronic Engineering – Harare Institute of Technology

Employment History

- o He worked at Onel Electrical Engineers as a trainee
- o Then he worked as a qualified technician from January 2009 to the time of his resignation to pursue his self-interests in Cank.
- o He has also worked for Pentagon Electrical, Clytech Services and Equal Image Fire Engineers amongst others.

Projects

- o Willowvale flats housing project
- o Mbada diamonds SVC at the Harare International Airport
- o Petrotrade service station in Warren Park, Harare
- o Refurbishment of Econet Graniteside, Harare
- o Sewage treatment plants in Chitungwiza
- o Housing projects at UNKI mine in Gweru
- o Refurbishing of White City Sports Stadium in Bulawayo



Marketing Director
Sheanesu Paula Motsi



Qualifications

- o Content Marketing Certified. Code:730ab66b3307483589103fd9e54069ef
- o Fundamentals of Digital Marketing Certified. I.D:LCP QDHRC8

Work Experience

- o Stratus Engineers: Digital Marketer
- o Uncommon.org: Volunteer for teaching code





Our Key Personnel



Projects Manager Engineer Tinashe Chiwayu



Qualifications

- o B.Eng. Honors Degree in Electronic Engineering NUST, Zimbabwe
- o Certificate in Project Management
Project Management Institution of Zimbabwe
- o Certified Yea Star VOIP Technician
- o Member of Zimbabwe Institute of Engineers (ZIE155355)

Work Experience

- o Graduate Trainee Telecoms Engineer Zimbabwe Electricity Transmission and Distribution Company
- o Telecoms Project Engineer - ZETDC
- o Support Services Engineer - Electrical and Electronics (Pito Investments)
- o Electrician - BL Herbert International (Westgate Compound US Embassy Construction)

Projects

- o Optical Ground Wire Fibre installation (Telecoms Tech at ZETDC)
- o Ripple Control System Pilot Project (Trainee Engineer ZETDC)
- o Two way mobile radio network installation in :
Masvingo, Gutu, Mashava, Chiredzi, Triangle and Rutenga (Acting Telecoms Engineer - ZETDC)
- o Installation of Fibre Optic Multiplexers (including Fibre laying and splicing) in :
Harare Bulawayo, Gwayi, Hwange and Victoria Falls (Engineer at Pito Investments)
- o Masvingo District Office IPBX Installation and commissioning (Engineer - ZETDC)
- o Harare and Bulawayo Substation Fibre Optic Networks (Projects Engineer ZETDC)



Electronic Services Engineer Engineer Kevin Ngalonde



Qualifications

- o B.Eng. Honors Degree in Electronic Engineering
NUST, Zimbabwe
- o Certificate in Data Networking
- o Certified VOIP Expert
- o Masters in Business Administration

Employment History

- o Econet - Linux and Network Engineer Trainee
- o Leabridge - Electronic Security Engineer
- o STC -Head ICT and Security Solutions

Projects

- o Barclays Bank Access Control, CCTV & Fire Alarm
- o CBZ Wealth Management Biometric Access Control & Mantraps
- o CBZ Fannum House Addressable Fire Alarm System
- o Mother Touch Group of Schools Network Setup & CCTV
- o Telone VOIP Solutions
- o BL Herbert US Embassy Westgate, Addressable Fire Alarm





Our Key Personnel



Electrical Services Engineer
Jacob Tafadzwa Godi

Qualifications

- o B.Sc. Honors Degree in Electrical Engineering
- o University of Zimbabwe

Work Experience

- o Planning and undertaking scheduled maintenance on transmission lines and substations up to 33Kv
- o Construction of transmission lines and substations (0.4Kv up to 33Kv)
- o Responding to faults
- o Diagnosing faults and Repairing equipment
- o Maintaining statistical records
- o Supervising technical staff
- o Ensuring compliance with health and safety legislation



Sales Manager
Andrew Chani

Qualifications

- o Honors Degree in Local Governance Studies
- o Honors Degree in Retail and Logistics (pending)

Employment History

- o Procurement Officer – Joyous Events Management
- o Dispatch Clerk – Silo Food Industries





Our Company Details

Name of Company:

Cank Electrical and Electronic Engineers (Pvt) Ltd

Address of Registered business:

111 Westwood Drive, Westwood, Harare, Zimbabwe

Principle place of business:

Suite 7 Monavale Shopping Complex, 177 Lyndhurst Road, Monavale, Harare, Zimbabwe

Company registration number:

6365/ 2014

Business partner (BP) number:

02000196174

Date of registration:

31 July 2014

NSSA Registration number:

C630

Bank Details:

Account name: Cank Electrical Engineers (Pvt) Ltd

Account number: 100-681-1171

Bank: Steward Bank

Branch: Kwame Nkrumah

Company Secretary:

Collins Tafadzwa Mano (collins@cankengineers.co.zw)

Email Address:

info@cankengineers.com cankengineers@gmail.com

Website address:

www.cankengineers.co.zw

Phone Number:

+263 8644 150 180

Mobile numbers:

+263 772 615 511 / +263 733 881 835 / +263 718 678 115

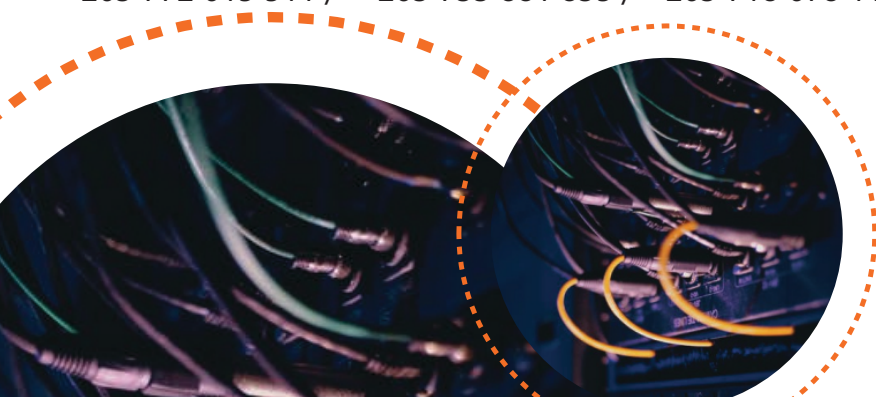
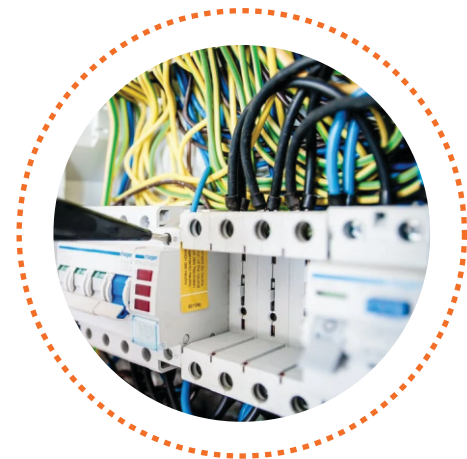



Our Company Documents

Receipt NO. DCD3/9851

ORIGINAL COPY

No. 6365/2014

USD20

Nº 154748



ZIMBABWE

REGISTRAR OF COMPANIES
EX 24

31 JUL 2014

PO BOX CY 177 CAUSEWAY
ZIMBABWE

Certificate of Incorporation

CANK ELECTRICAL ENGINEERS (PRIVATE) LIMITED

I hereby certify that.....

.....

is this day incorporated under the Companies Act [Chapter 24:03] and that the Company is Limited.

Given under my Hand and Seal at..... HARARE

this 31ST day of JULY, 20 14



Registrar of Companies





Our Company Documents



Zimbabwe Revenue Authority

Tax Clearance Certificate (ITF263)

Tax Year Ending 31 December 2023

Cank Electrical Engineers Cank Electrical Engineers

Business Partner Number: 0200196174

Your Tax position is Satisfactory. No 10% tax should be withheld

Clearance issued on 04/04/2022 at 07:40:16 valid until 03/31/2023

Authentication code: QCQQ.ZNY4.76FF.QSLQ

The authentication and validity of this certificate must be validated on ZIMRA page at: <http://efiling.zimra.co.zw>

